

SHELVING

by **kerkmann**

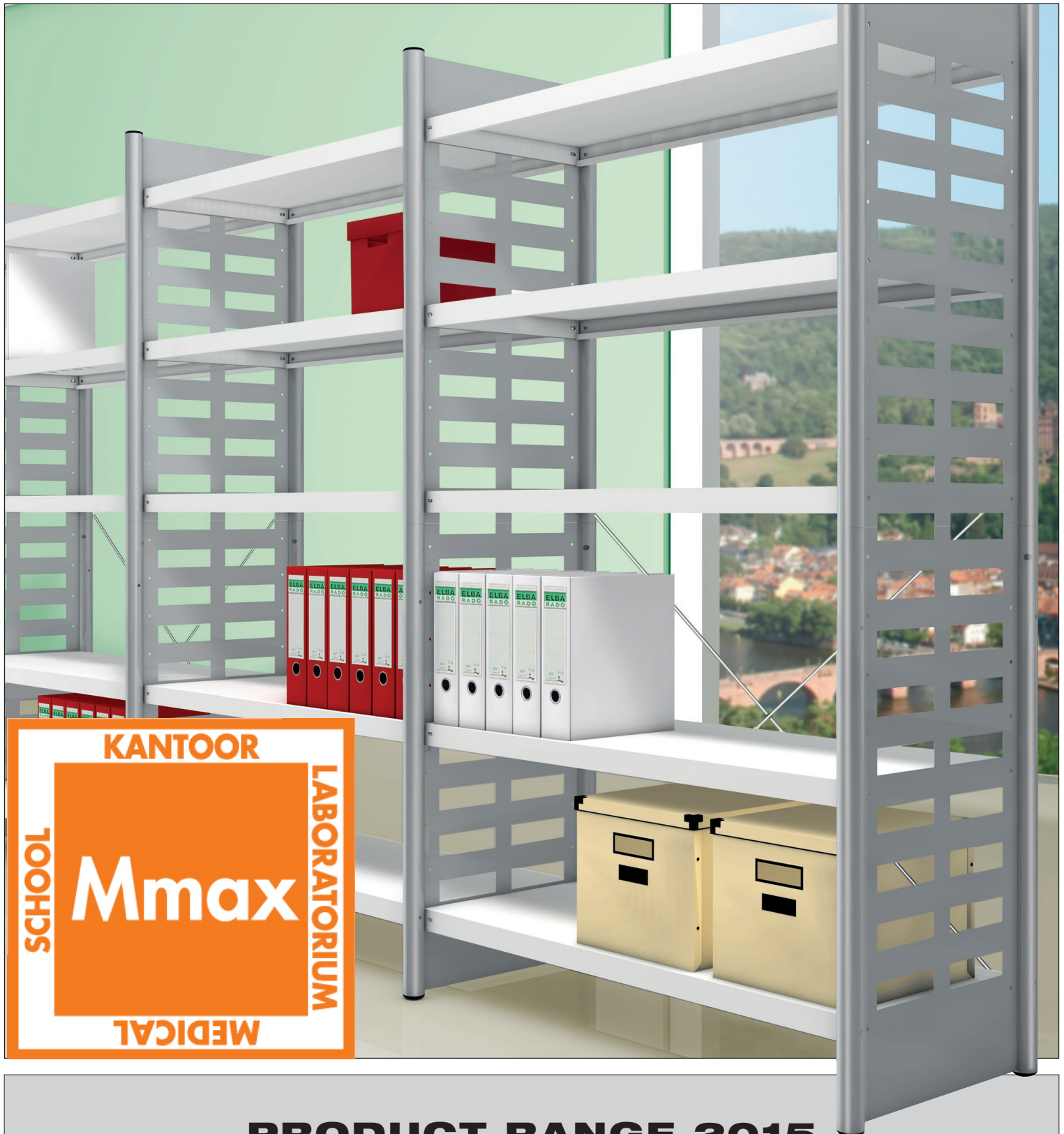

PRODUCT RANGE 2015



HIGHLIGHT

Hygienic shelving GalvaMed



GalvaMed for stringent hygienic requirements

Ideal for all highly sensible health areas such as: Hospitals, Clinics, Laboratories, Nursing homes, Doctors surgeries, Manufacturers of medicinal products. Is treated with a special anti-bacterial coating conforming to ISO 22196 combating against the inhibition and re-emergence of bacteria. The antibacterial reduction value of this surface according to ISO 22196 against the strain of bacteria MRSA, Staphylococcus aureus, Pseudomonas aeruginosa and also against E-Coli bacteria is verified at 99,99%. This has been certified by the Independent Quality Laboratory Institute. Optimal use of available room space is achieved by a combination of 2 widths and 2 depth variants. Each shelf is adjustable in 59 mm steps. The uprights are supplied with lateral side securing metal strips. Load capacity (per shelf) 150 kg.

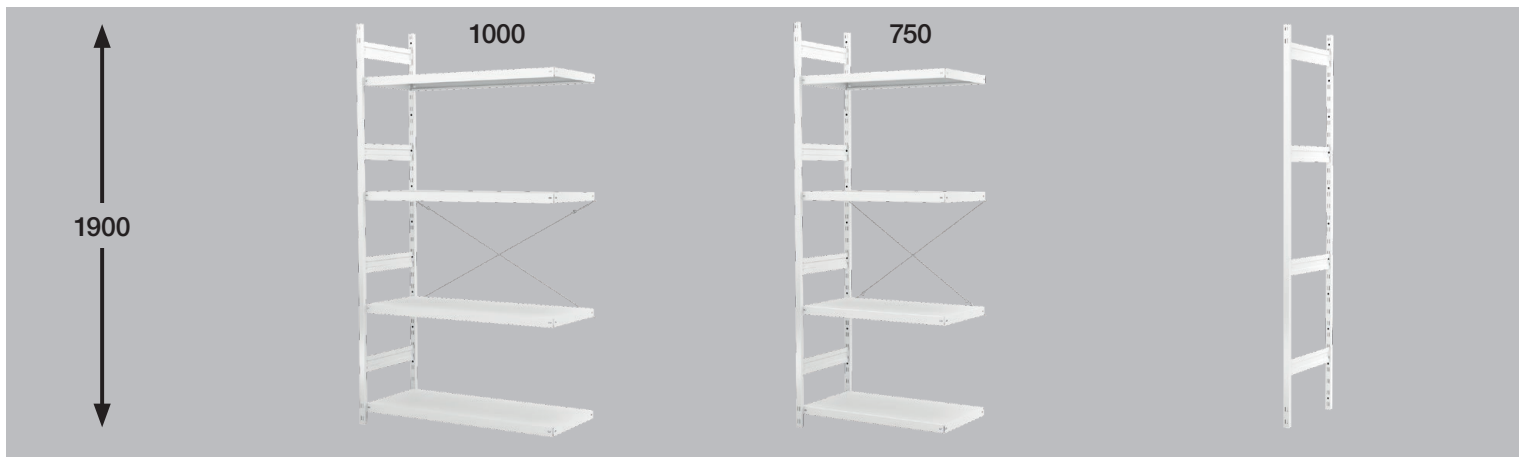

1900 mm high with 4 Shelves		Shelf width 1000 mm	Shelf width 750 mm	End upright
400 Deep	white	Part-No: 2035	Part-No: 2036	Part-No: 2037
	€	266,30	252,50	102,10
600 Deep	white	Part-No: 2040	Part-No: 2041	Part-No: 2042
	€	329,80	316,-	113,10



Storage shelving

Stora 100	4-5
Status	6-7
Design shelving M2	8-9
Hygienic shelving Galva / GalvaMed	10-11



Office shelving

Progress 500	12-13
Progress 2000	14-15



Library shelving

Univers	16-17
Libra	18-19

Storage shelving *Stora 100*



STORA 100

Medium construction for load capacity up to 100 kg *

Extremely stable slot assembly elements, the use of corner units and combination of 1000 and 750 mm wide shelving allows optimal usage of room space. Available in 3 different heights and 4 depth ranges, either with or without rear walls, and upright side panel fascia. Frame uprights are steel box section with smooth front surfaces. Shelves have a 40 mm edging for greater stability and are height adjustable in 59 mm steps. Load capacity per shelf 100 kg. All parts are polyester powder coated, in the following colour combinations, black RAL 9011 and light grey RAL 7035 or silver RAL 9006 and light grey RAL 7035.

Width of shelving unit = Quoted dimension + 30 mm, and additional 10 mm per
Depth of unit = Quoted dimension + 40 mm

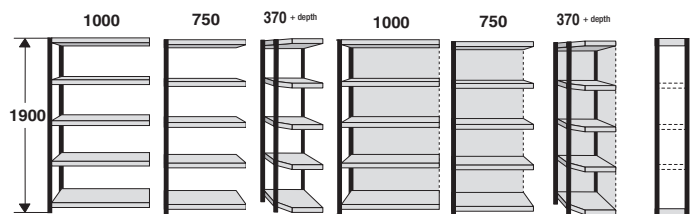
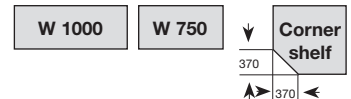

H 1900 mm with 5 shelves

with rear wall

		Add-on W 1000	Add-on W 750	Square Add-on 370 + depth	Add-on W 1000 with rear wall	Add-on W 750 with rear wall	Corner Add-on 370 + Tiefe with rear wall	End support
D 300	black/light-grey	2401	2405	2409	2413	2417	2421	2425
	silver/light-grey	2485	2486	2487	2537	2538	2539	2488
	€	136,-	128,-	235,-	229,-	214,-	342,-	47,-
D 400	black/light-grey	2402	2406	2410	2414	2418	2422	2426
	silver/light-grey	2619	2620	2621	2540	2541	2542	2622
	€	166,-	159,-	263,-	259,-	246,-	372,-	49,-
D 500	black/light-grey	2403	2407	2411	2415	2419	2423	2427
	silver/light-grey	2639	2640	2641	2543	2544	2545	2642
	€	193,-	183,-	318,-	279,-	265,-	429,-	56,-
D 600	black/light-grey	2404	2408	2412	2416	2420	2424	2428
	silver/light-grey	2659	2660	2661	2550	2551	2552	2662
	€	209,-	199,-	345,-	299,-	279,-	457,-	59,-

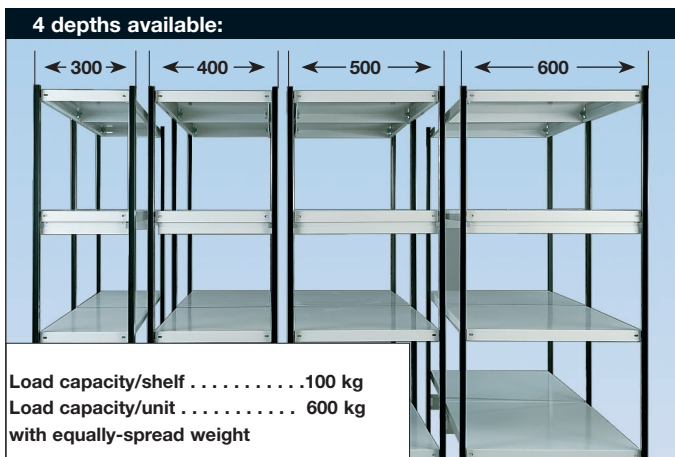

Side fascia for uprights.

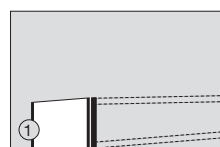

	Side fascia H 1900
D 300	8403 33,-
D 400	8413 43,-
D 500	8460 47,-
D 600	8437 55,-

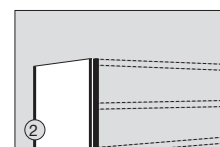

	Side fascia H 2250
D 300	8409 43,-
D 400	8411 48,-
D 500	8467 59,-
D 600	8438 68,-

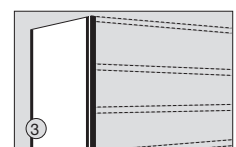

	Side fascia H 2600
D 300	8410 49,-
D 400	8412 58,-
D 500	8468 68,-
D 600	8439 77,-

*For increased load capacity, please see shelving Progress 2000, p 14/15

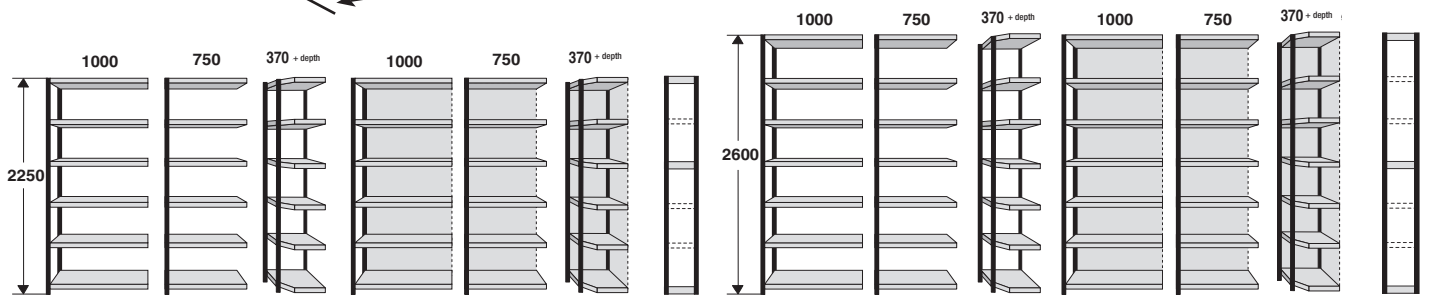

H 2250 mm with 6 shelves

with rear wall

H 2600 mm with 7 shelves

with rear wall

D		H 2250 mm with 6 shelves			with rear wall			Corner unit 370 + depth with rear wall	Final support	H 2600 mm with 7 shelves			with rear wall			Corner unit 370 + depth with rear wall	End support
		Add-on W 1000	Add-on W 750	Square Add-on 370 + depth	Add-on with rear wall W 1000	Add-on with rear wall W 750	Add-on W 1000			Add-on W 750	Add-on with rear wall W 1000	Add-on with rear wall W 750					
300	black/light-grey	2429	2433	2437	2441	2445	2449	2453	2457	2461	2465	2469	2473	2477	2481		
	silver/light-grey	2490	2491	2492	2560	2561	2562	2493	2495	2496	2497	2595	2596	2597	2498		
	€	166,-	159,-	282,-	279,-	272,-	409,-	64,-	195,-	185,-	321,-	318,-	305,-	482,-	74,-		
400	black/light-grey	2430	2434	2438	2442	2446	2450	2454	2458	2462	2466	2470	2474	2478	2482		
	silver/light-grey	2623	2624	2625	2563	2564	2565	2626	2627	2628	2629	2598	2599	2600	2630		
	€	199,-	192,-	318,-	309,-	297,-	440,-	74,-	236,-	223,-	356,-	360,-	347,-	515,-	79,-		
500	black/light-grey	2431	2435	2439	2443	2447	2451	2455	2459	2463	2467	2471	2475	2479	2483		
	silver/light-grey	2643	2644	2645	2566	2567	2568	2646	2647	2648	2649	2601	2602	2603	2650		
	€	229,-	224,-	386,-	340,-	329,-	517,-	79,-	265,-	254,-	429,-	399,-	386,-	584,-	82,-		
600	black/light-grey	2432	2436	2440	2444	2448	2452	2456	2460	2464	2468	2472	2476	2480	2484		
	silver/light-grey	2663	2664	2665	2590	2591	2592	2666	2667	2668	2669	2604	2605	2606	2670		
	€	265,-	259,-	409,-	378,-	354,-	579,-	85,-	299,-	285,-	489,-	429,-	417,-	645,-	88,-		

Additional equipment

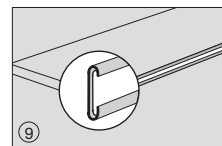
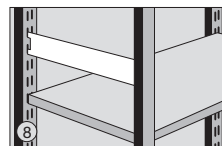
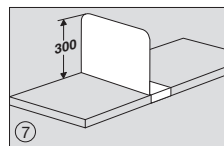
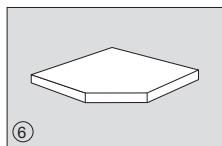
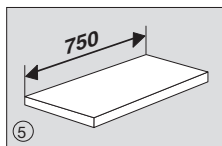
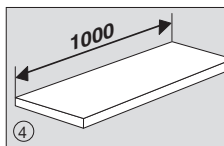

	Shelf H 1000	Shelf H 750	Corner shelf	Movable divider	Side support	Label chanel					
D 300	5943	14,90	5947	14,20	5957	29,10	5963	12,80	8406	3,60	transparent plastic, self-adhesive, with white cardboard
D 400	5944	19,40	5948	18,90	5958	32,80	5964	14,50	8407	3,90	
D 500	5945	23,80	5949	23,10	5959	43,50	5965	17,-	8476	4,70	
D 600	5946	28,20	5950	27,30	5960	47,60	5966	19,-	8408	5,80	
											5133 per metre 4,80

Storage shelving *Status*

Upright supports
in blue or alusilver
colour

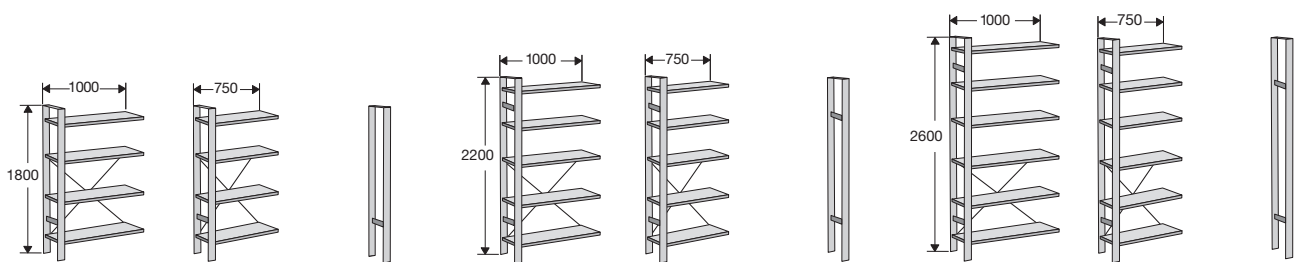

	Height 1800 mm with 4 shelves			Height 2200 mm with 5 shelves			Height 2600 mm with 6 shelves			
	depth mm	Shelf W 1000 mm	Shelf W 750 mm	End support	Shelf W 1000 mm	Shelf W 750 mm	End support	Shelf W 1000 mm	Shelf W 750 mm	End support
alusilver	300	# 7116	# 7117	# 7140	# 7126	# 7127	# 7141	# 7136	# 7137	# 7142
blue	300	# 7260 169,-	# 7264 164,-	# 7268 115,-	# 7272 214,-	# 7276 203,-	# 7280 125,-	# 7284 260,-	# 7288 254,-	# 7292 150,-
alusilver	400	# 7110	# 7113	# 7101	# 7120	# 7123	# 7104	# 7130	# 7133	# 7107
blue	400	# 7261 199,-	# 7265 189,-	# 7269 122,-	# 7273 241,-	# 7277 231,-	# 7281 138,-	# 7285 279,-	# 7289 268,-	# 7293 171,-
alusilver	500	# 7111	# 7114	# 7102	# 7121	# 7124	# 7105	# 7131	# 7134	# 7108
blue	500	# 7262 229,-	# 7266 219,-	# 7270 135,-	# 7274 273,-	# 7278 262,-	# 7282 152,-	# 7286 325,-	# 7290 315,-	# 7294 187,-
alusilver	600	# 7112	# 7115	# 7103	# 7122	# 7125	# 7106	# 7132	# 7135	# 7109
blue	600	# 7263 274,-	# 7267 262,-	# 7271 152,-	# 7275 316,-	# 7279 305,-	# 7283 178,-	# 7287 364,-	# 7291 354,-	# 7295 200,-

Storage shelving Status



Storage shelving Status

A highly stable and sturdy shelving system. Each single unit has a load capacity of 750 kg. The load capacity of each shelf is 100-150 kg. A combination of 1000 and 750 mm widths enable optimal room utilization. Stable square box section uprights in alusilver or blue colour. The shelves in light grey with a 40 mm edge. The shelves are adjustable in height in steps of 92 mm, enabling flexibility depending on what you wish to store. These units are available in 3 heights (1800, 2200, and 2600 mm) and 4 depths (300, 400, 500 and 600 mm).

Load capacity of shelves:

- Depth 300 und 400 mm = 100 kg each
- Depth 500 und 600 mm = 120 kg each
- With 1 shelf support = + 30 kg

Add-on
from **164,-**



Accessories:

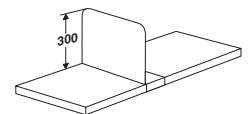
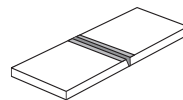
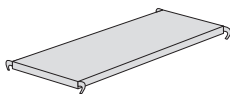

	Additional shelf		Shelf support (max. 1 per shelf) TIncrease in carrying capacity/shelf: 30 kg (to be placed underneath the shelf)		Movable shelf dividers H 300 mm	
	W 1000 mm	W 750 mm				
D 300	# 7170 € 15,-	# 7174 € 14,20			# 5963 € 12,80	
D 400	# 7171 € 19,40	# 7175 € 18,90	# 5987 € 4,90		# 5964 € 14,50	
D 500	# 7172 € 23,80	# 7176 € 23,10	# 5988 € 5,30		# 5965 € 17,-	
D 600	# 7173 € 28,20	# 7177 € 27,30	# 5989 € 5,80		# 5966 € 19,-	

Design-shelving M2



Extremely stable with a high load capacity.

This modern designed racking system M2, is extremely stable with a high load capacity. Utilizing the corner racks and the combination of widths from 1000 and 750 mm allows optimal usage of all available space. The shelving is light grey in colour (RAL 7035) and is available in 400, 500 and 600 mm depths. Each shelf has a safety edge of 40 mm, the shelves can be adjusted by height in 86 mm steps by simply slotting into the next slit. The side stands (horizontal elements) are constructed of round metal tubing (Ø 40 mm) with welded side panels, which are powder coated in aluminium silver colour.

Three heights are available: 1800, 2200 and 2600 mm.

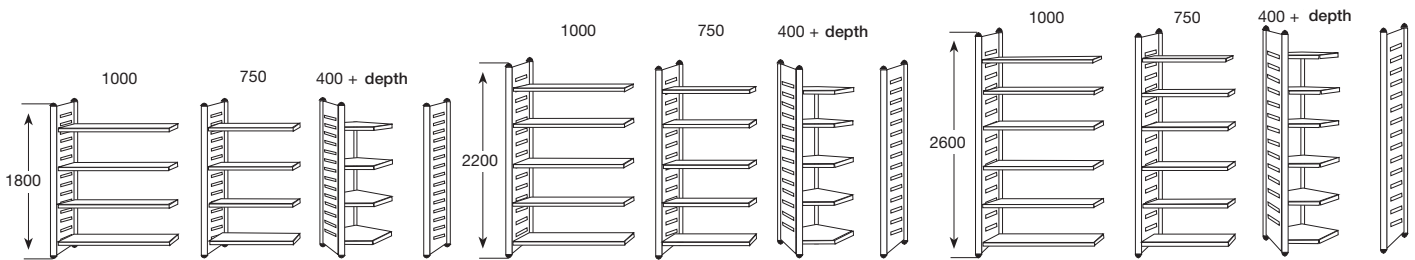

	1800 mm with 4 shelves				2200 mm with 5 shelves				2600 mm with 6 shelves			
	Add on W 1000	Add on W 750	Square add on 400+ depth	End support	Add on W 1000	Add on W 750	Corner add on 400+ depth	End support	Add on W 1000	Add on W 750	Corner add on 400+ depth	End support
D=400	5802 € 190,-	5806 € 178,-	5810 € 284,-	5826 € 116,-	5830 € 229,-	5834 € 222,-	5838 € 328,-	5854 € 129,-	5858 € 264,-	5862 € 256,-	5866 € 397,-	5882 € 158,-
D=500	5803 € 219,-	5807 € 211,-	5811 € 336,-	5827 € 130,-	5831 € 259,-	5835 € 254,-	5839 € 390,-	5855 € 145,-	5859 € 318,-	5863 € 305,-	5867 € 461,-	5883 € 178,-
D=600	5804 € 249,-	5808 € 245,-	5812 € 371,-	5828 € 139,-	5832 € 294,-	5836 € 288,-	5840 € 439,-	5856 € 154,-	5860 € 349,-	5864 € 342,-	5868 € 519,-	5884 € 188,-

Design-shelving M2

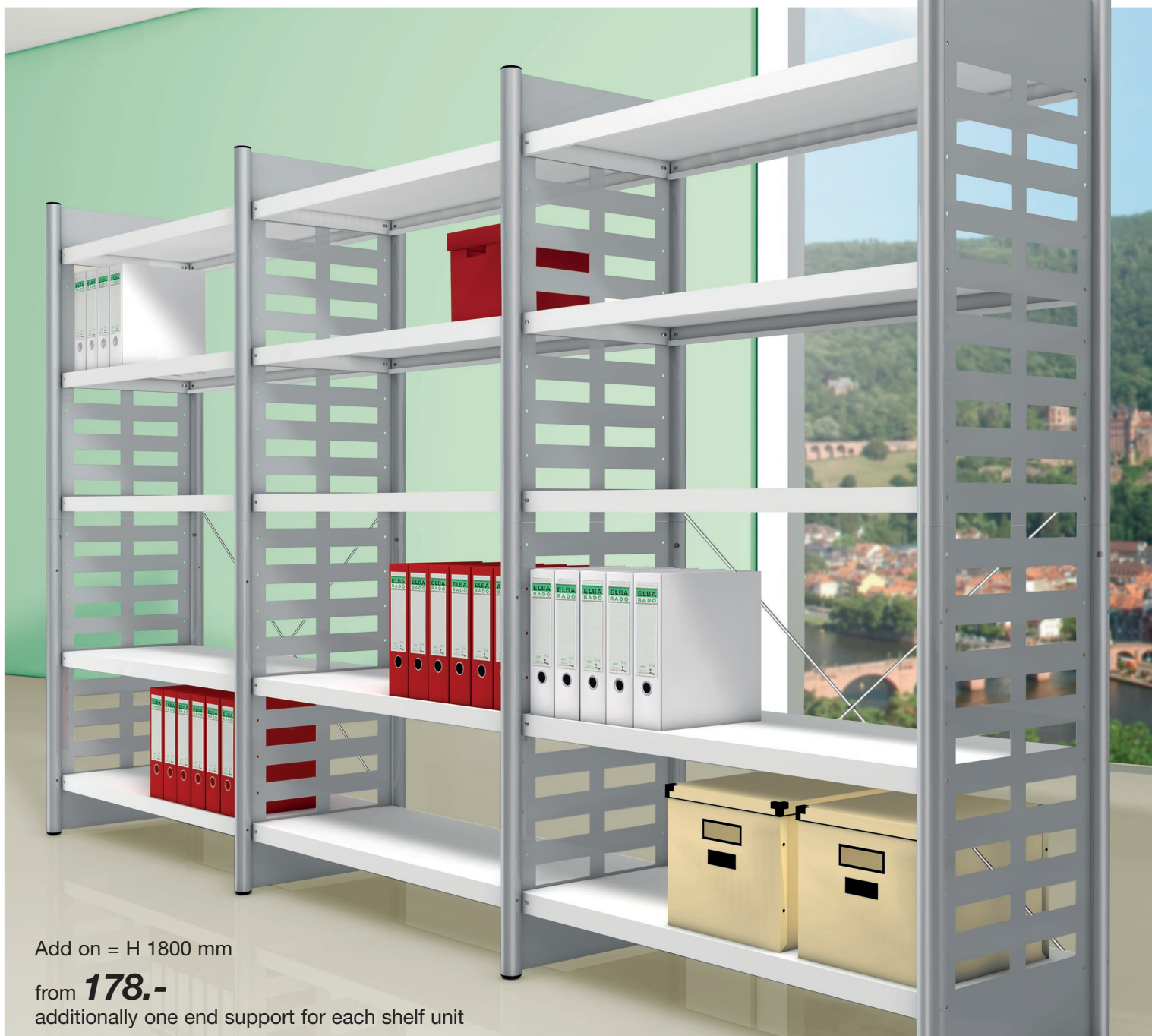

Add on = H 1800 mm

from **178.-**

additionally one end support for each shelf unit

capacity per shelf payload per shelf with supports **120 kg up to 200 kg**
capacity per add on payload per shelf **1000 kg**
 Width per unit = quoted width + 40 mm

Safety advice:

Shelves with height/depth proportions > 5:1 have to be secured to avoid tilting (wall or floor fixing)

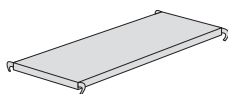

	Additional shelves		
	W 1000	W 750	Corner
D=400	5900 € 19,40	5905 € 18,90	5910 € 32,80
D=500	5901 € 23,80	5906 € 23,10	5911 € 43,50
D=600	5902 € 28,20	5907 € 27,30	5912 € 47,60

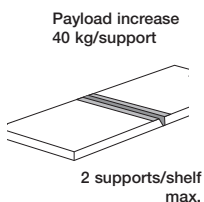

	shelf supports
D=400	5987 € 4,90
D=500	5988 € 5,30
D=600	5989 € 5,80

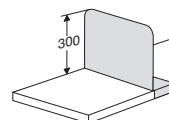

	movable divider
D=400	5964 € 14,50
D=500	5965 € 17,-
D=600	5966 € 19,-

Hygienic shelving Galva



Galva *ideal for Gastronomy and Hotels*

Extremely stable slot assembly elements, with special powder coating. The zinc plating has a hygienic powder coated surface. This hygienic surface conforms to the all required standards, codes, regulations and laws for the storage of food (LFGB).

Optimal use of available room space is achieved by a combination of 2 widths and 2 depth variants. Each shelf is adjustable in 59 mm steps.

The uprights are supplied with lateral side securing metal strips.

Load capacity (per shelf) 150 kg.

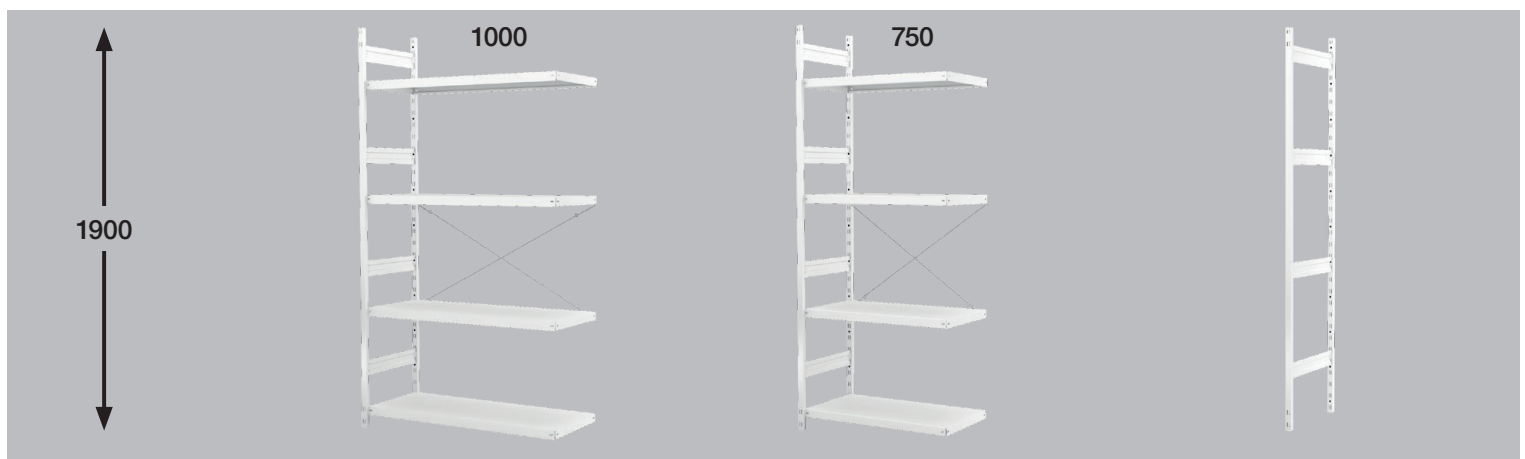

1900 mm high with 4 Shelves		Shelf width 1000 mm	Shelf width 750 mm	End upright
400 Deep	white	Part-No: 2025	Part-No: 2026	Part-No: 2027
	€	193,-	183,-	74,-
600 Deep	white	Part-No: 2031	Part-No: 2032	Part-No: 2033
	€	239,-	229,-	82,-

Hygienic shelving GalvaMed



GalvaMed for stringent hygienic requirements

Ideal for all highly sensible health areas such as: Hospitals, Clinics, Laboratories, Nursing homes, Doctors surgeries, Manufacturers of medicinal products. Is treated with a special anti-bacterial coating conforming to ISO 22196 combating against the inhibition and re-emergence of bacteria. The antibacterial reduction value of this surface according to ISO 22196 against the strain of bacteria MRSA, Staphylococcus aureus, Pseudomonas aeruginosa and also against E-Coli bacteria is verified at 99,99%. This has been certified by the Independent Quality Laboratory Institute. Optimal use of available room space is achieved by a combination of 2 widths and 2 depth variants. Each shelf is adjustable in 59 mm steps. The uprights are supplied with lateral side securing metal strips. Load capacity (per shelf) 150 kg.

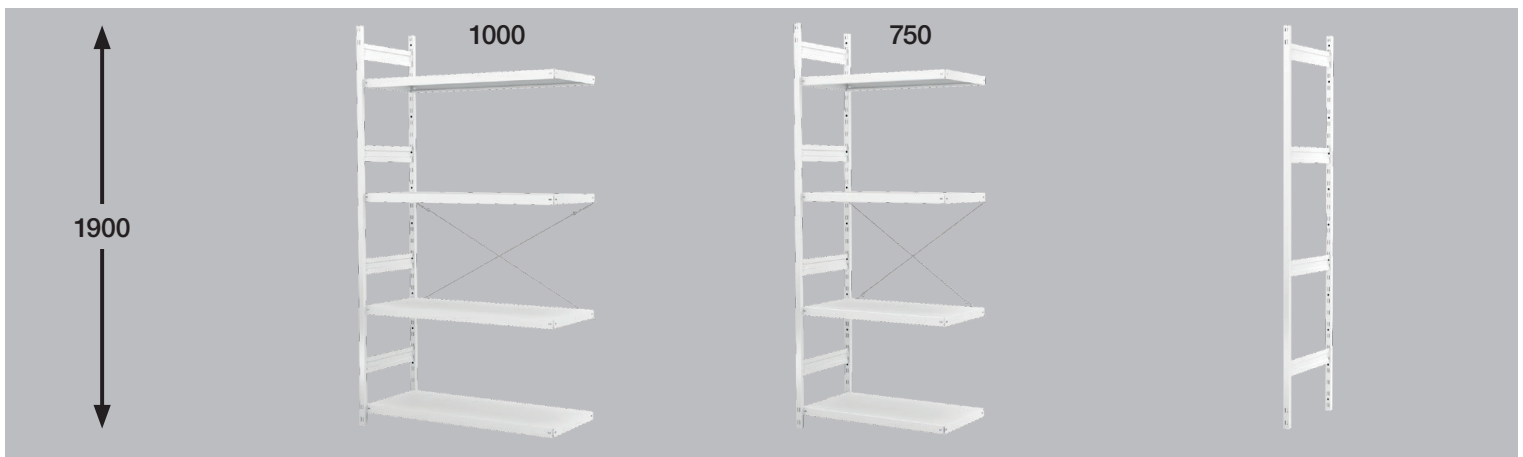

1900 mm high with 4 Shelves		Shelf width 1000 mm	Shelf width 750 mm	End upright
400 Deep	white	Part-No: 2035	Part-No: 2036	Part-No: 2037
	€	266,30	252,50	102,10
600 Deep	white	Part-No: 2040	Part-No: 2041	Part-No: 2042
	€	329,80	316,-	113,10

Office shelving Progress 500

Office shelving Progress 500

- Made of high quality steel
- An extremely stable slot-in system assembly
- Additional door assemblies in light grey or graphite
- All shelving is designed for file height
- Complete with floor plinths
- 2 width variants for optimal room usage
- Square steel profile uprights with smooth front edging
- Shelves are 30 mm high and are adjustable in height up to 59 mm
- Powder coated in light grey RAL 7035 colour
- Width per rack = nominal length + 30mm



Complete shelves

Load capacity per unit: 300/400 deep: 60 kg, 600 deep: 80 kg

Load capacity per rack: 500 kg

Shelving without rear wall				Shelving with rear wall									
		H 1900 mm with 6 shelves = 5 levels		H 2250 mm with 7 shelves = 6 levels		H 2600 mm with 8 shelves = 7 levels		H 1900 mm with 6 shelves = 5 levels		H 2250 mm with 7 shelves = 6 levels		H 2600 mm with 8 shelves = 7 levels	
Width mm	Depth mm	Base rack	Add-on	Base rack	Add-on	Base rack	Add-on	Base rack	Add-on	Base rack	Add-on	Base rack	Add-on
960	300	9400	9450	9401	9451	9402	9452	9412	9462	9413	9463	9414	9464
	€	189,-	149,-	244,-	183,-	286,-	214,-	279,-	244,-	345,-	289,-	418,-	343,-
	400	9403	9453	9404	9454	9405	9455	9415	9465	9416	9466	9417	9467
	€	229,-	183,-	279,-	220,-	334,-	253,-	322,-	278,-	379,-	327,-	466,-	391,-
	600	9409	9459	9410	9460	9411	9461	9421	9471	9422	9472	9423	9473
	€	299,-	245,-	345,-	293,-	424,-	342,-	383,-	331,-	458,-	391,-	537,-	467,-
750	300	9500	9550	9501	9551	9502	9552	9512	9562	9513	9563	9514	9564
	€	186,-	141,-	233,-	178,-	281,-	205,-	274,-	241,-	338,-	283,-	392,-	336,-
	400	9503	9553	9504	9554	9505	9555	9515	9565	9516	9566	9517	9567
	€	222,-	179,-	275,-	216,-	329,-	249,-	317,-	271,-	372,-	321,-	457,-	381,-
	600	9509	9559	9510	9560	9511	9561	9521	9571	9522	9572	9523	9573
	€	292,-	234,-	342,-	289,-	418,-	335,-	378,-	327,-	447,-	382,-	537,-	457,-

Shelving units for double-sided use



Accessories:

1 Level support (so nothing falls out)			
Depth mm	Part - No.	€	
300	8406	3,60	
400	8407	3,90	
600	8408	5,80	
2 Fixed divider applicable for 600 mm deep shelves			
Depth mm	Width 960 mm	Width 750 mm	
600	5937	5936	
€	6,60	6,40	
3 Divider movable			
Depth mm	Part - No.	€	
300	8719	7,80	
400	8446	8,50	
600	8472	13,40	

Office shelving Progress 500

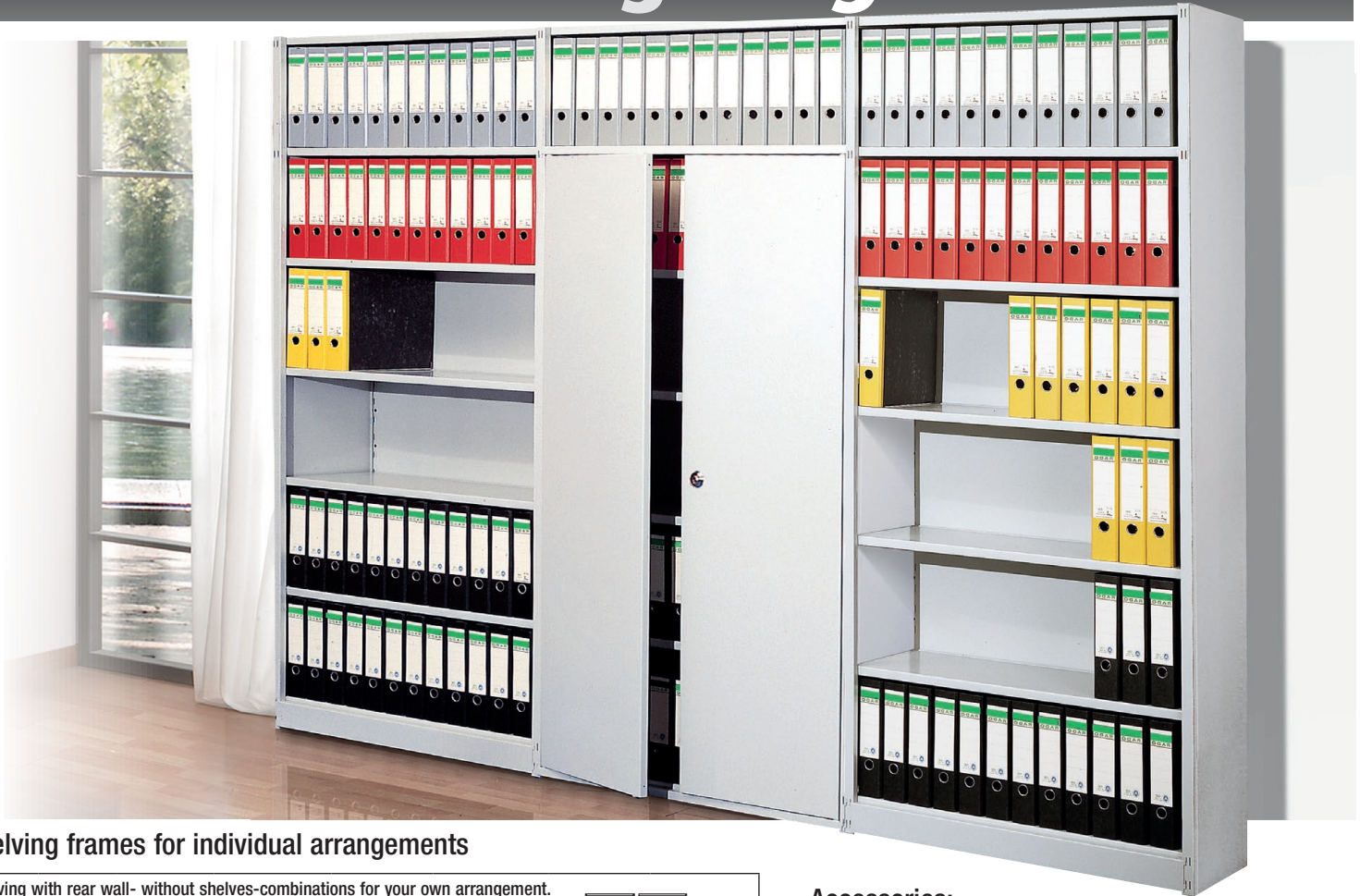

Shelving frames for individual arrangements

Shelving with rear wall- without shelves-combinations for your own arrangement.

		H 1900 mm with top and bottom shelf		H 2250 mm with top and bottom shelf		H 2600 mm with top and bottom shelf	
Width mm	Depth mm	Base rack	Add-on	Base rack	Add-on	Base rack	Add-on
960	300	9436	9486	9437	9487	9438	9488
	€	229,-	180,-	277,-	218,-	322,-	261,-
	400	9439	9489	9440	9490	9441	9491
	€	252,-	199,-	295,-	230,-	354,-	278,-
	600	9445	9495	9446	9496	9447	9497
	€	286,-	229,-	326,-	261,-	395,-	308,-
750	300	9536	9586	9537	9587	9538	9588
	€	225,-	185,-	272,-	214,-	317,-	253
	400	9539	9589	9540	9590	9541	9591
	€	249,-	197,-	287,-	227,-	346,-	271,-
	600	9545	9595	9546	9596	9547	9597
	€	282,-	223,-	324,-	253	387,-	299,-

Examples of shelf combination possibilities Height 2250 mm



Shelf frame (base)
5 shelves
1 side wall assy

Shelf frame (add-on)
6 hanging file supports

Shelf frame (add-on)
5 shelves
1 set of doors

Shelf frame (add-on)
1 floor shelf
1 side wall assy
1 wardrobe rack rail
1 set of doors

Accessories:

Shelves for shelving frames or as additional shelves for complete shelving units

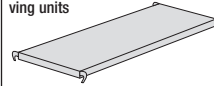

Depth mm	Width in mm	
	960	750
300	8400	8401
€	14,-	13,50
400	8417	8418
€	18,80	18,40
600	8424	8425
€	25,80	25,50

Hanging-file support

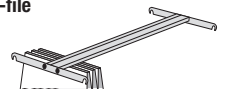

Depth mm	Width 960 mm	Width 750 mm
400	5426	5425
€	24,70	23,40

side fascia for end uprights

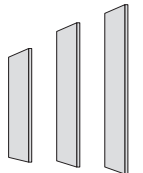

Depth mm	Width in mm		
	1900	2250	2600
300	8403	8409	8410
€	33,-	43,-	49,-
400	8413	8411	8412
€	43,-	48,-	58,-
600	8437	8438	8439
€	55,-	68,-	77,-

Wardrobe rail with hat/storage level, width 750mm

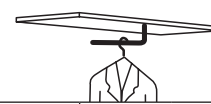

Depth mm	€	
300	5413	39,50
400	5414	47,20

Pair of doors H 1900 mm

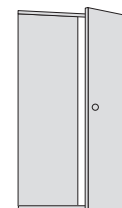

Wall divider as inner side wall when doors are assembled.

Doors Color	Width mm	
	960	750
Light-grey	8414	8435
Graphite-grey	8490	8489
€	224,-	214,-

Wall divider applicable for doors		
Depth mm	€	
300	8415	29,90
400	8416	38,80
600	8426	54,90

Office shelving Progress 2000

PROGRESS 2000

Extremely stable metal office shelving

Made of high quality steel.

- An extremely stable slot-in System assembly
- Optimal usage of room space due to variable widths of 1000 and 750 mm
- Shelves adjustable in height of 59mm
- high quality powder coated in black (RAL 9011) Silver (RAL 9006) and light grey (RAL 7035)
- Load capacity (per shelf)
 - up to 400 mm deep 100 kg
 - from 500 mm deep 120 kg
 - with extra supports up to 200 kg
- Bay load (load per unit): 1000 kg
- Width per shelf unit = stated width + 30 mm

Shelf outer dimension: depth (D) + 40 mm
 Width (without corner unit) = shelf width + 30 mm
 Width corner unit = shelf width + 30 mm
 The bottom front floor panel of the corner unit measures 505 mm



Unit without rear wall

Unit with rear wall

from **237,-**
 Add-on
 with rear wall

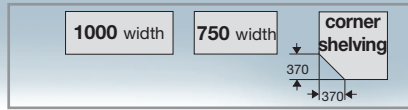

Shelving without rear wall

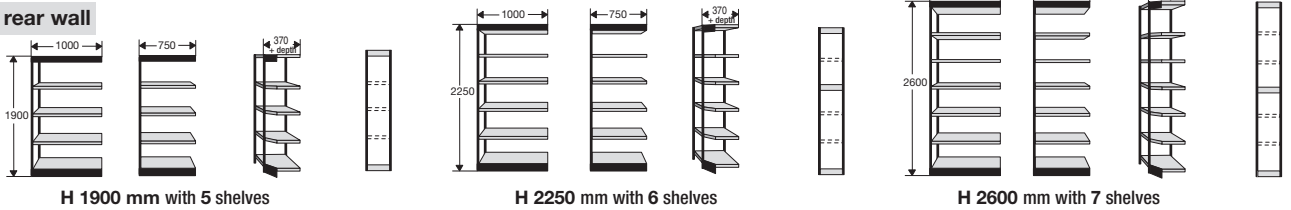

	Frame-color	Add-on W 1000	Add-on W 750	Square Add-on 370 + depth	End support	Add-on W 1000	Add-on W 750	Square Add-on 370 + depth	End support	Add-on W 1000	Add-on W 750	Square Add-on 370 + depth	End support
D 300	black	2111	2115	2181	2088	2131	2135	2185	2092	2151	2155	2189	2096
D 300	silver	2900	2904	2908	2010	2912	2916	2920	2014	2924	2928	2932	2018
		159,-	149,-	242,-	47,-	193,-	183,-	291,-	64,-	214,-	211,-	322,-	74,-
D 400	black	2112	2116	2182	2089	2132	2136	2186	2093	2152	2156	2190	2097
D 400	silver	2901	2905	2909	2011	2913	2917	2921	2015	2925	2929	2933	2019
		192,-	179,-	255,-	50,-	229,-	219,-	317,-	71,-	259,-	252,-	363,-	78,-
D 500	black	2113	2117	2183	2090	2133	2137	2187	2094	2153	2157	2191	2098
D 500	silver	2902	2906	2910	2012	2914	2918	2922	2016	2926	2930	2934	2020
		214,-	203,-	322,-	58,-	256,-	251,-	387,-	78,-	289,-	282,-	444,-	81,-
D 600	black	2114	2118	2184	2091	2134	2138	2188	2095	2154	2158	2192	2099
D 600	silver	2903	2907	2911	2013	2915	2919	2923	2017	2927	2931	2935	2021
		236,-	229,-	345,-	59,-	289,-	282,-	429,-	83,-	322,-	315,-	491,-	85,-

Increase up to load capacity 40 kg/ support

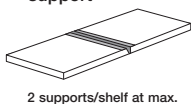

Depth	Shelf support	Movable divider	Level support
300		5963 12,80	8406 3,60
400	5987 4,90	5964 14,50	8407 3,90
500	5988 5,30	5965 17,-	8476 4,70
600	5989 5,80	5966 19,-	8408 5,80

Additional shelves

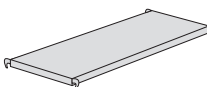

Depth	W 1000	W 750	Corner shelves
300	5943 14,90	5947 14,20	5957 29,10
400	5944 19,40	5948 18,90	5958 32,80
500	5945 23,80	5949 23,10	5959 43,50
600	5946 28,20	5950 27,30	5960 47,60

available for 600 mm deep shelves

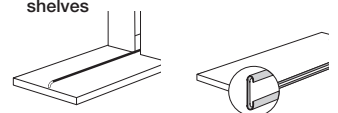

Fixed Support	Label holder
W 1000	transparent plastic, self-adhesive with white cardboard
5938	
W 750	
5936	5133 per metre 4,80

Office shelving Progress 2000



Shelving with rear wall

(see Fig. on left hand side of catalogue – shelves with back panels)

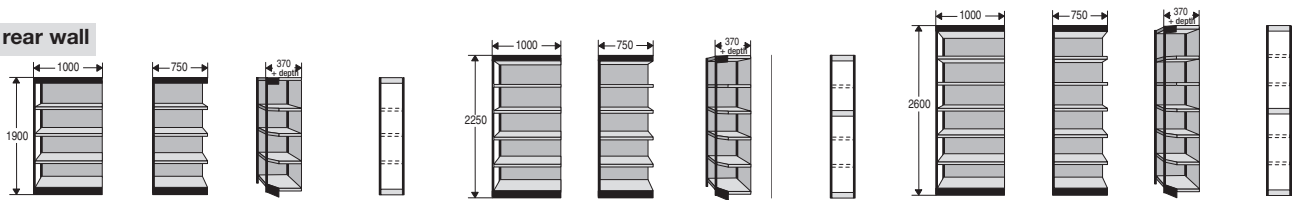

H 1900 with rear wall and 5 shelves

H 2250 with rear wall and 6 shelves

H 2600 with rear wall and 7 shelves

	Frame-color	Add-on W 1000	Add-on W 750t	Corner Add-on 370 + depth	End support	Add-on W 1000	Add-on W 750	Corner Add-on 370 + depth	End support	Add-on W 1000	Add-on W 750	Corner Add-on 370 + depth	End support
D 300	black	2211	2215	2281	2088	2231	2235	2285	2092	2251	2255	2289	2096
D 300	silver	2800	2804	2808	2010	2812	2816	2820	2014	2824	2828	2832	2018
		245,-	237,-	349,-	47,-	295,-	286,-	418,-	64,-	343,-	332,-	483,-	74,-
D 400	black	2212	2216	2282	2089	2232	2236	2286	2093	2252	2256	2290	2097
D 400	silver	2801	2805	2809	2011	2813	2817	2821	2015	2825	2829	2833	2019
		276,-	271,-	372,-	50,-	335,-	327,-	444,-	71,-	385,-	372,-	511,-	78,-
D 500	black	2213	2217	2283	2090	2233	2237	2287	2094	2253	2257	2291	2098
D 500	silver	2802	2806	2810	2012	2814	2818	2822	2016	2826	2830	2834	2020
		293,-	286,-	439,-	58,-	363,-	352,-	526,-	78,-	418,-	409,-	587,-	81,-
D 600	black	2214	2218	2284	2091	2234	2238	2288	2095	2254	2258	2292	2099
D 600	silver	2803	2807	2811	2013	2815	2819	2823	2017	2827	2831	2835	2021
		322,-	317,-	469,-	59,-	409,-	391,-	586,-	83,-	457,-	446,-	630,-	85,-

Accessories:

Depth	Side panel	H 2250 mm		H 2600 mm	
300	8403 33,-	8409 43,-	8410 49,-		
400	8413 43,-	8411 48,-	8412 58,-		
500	8460 47,-	8467 59,-	8468 68,-		
600	8437 55,-	8438 68,-	8439 77,-		

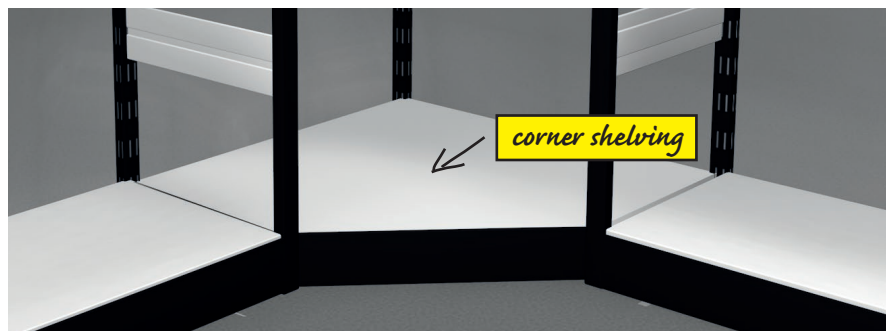

Cantilever shelving *Univers*



Cantilever shelving *Univers*, continuous shelving without end frame supports. Slot-in assembly.





These shelving units have no end frame supports and are quick and easy to erect due to the slot-in assembly system.

The individual shelves can be easily changed and varied. The height of shelves is variable in 16 mm steps.

Files of varying depths and construction can be easily stored. The combination of the varying widths available of 1000 and 750 mm allows optimal usage of room space.

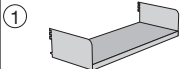
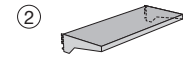
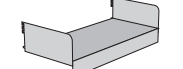
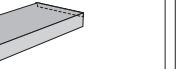
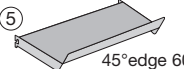
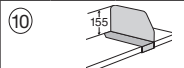
All components are of high quality steel with a polyester coating except for the cabinets which are E1-wood and have melamine coated surfaces. Shelving colour: light grey RAL 7035

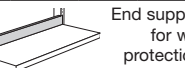
		Complete shelving one-sided				Complete shelving double-sided			
Complete shelves		H 2000 mm with 5 shelves		H 2250 mm with 6 shelves		H 2000 mm with 2 x 5 shelves		H 2250 mm with 2 x 6 shelves	
Width	Depth	Base unit	Add-on	Base unit	Add-on	Base unit	Add-on	Base unit	Add-on
1000	250	8802 318,-	8803 251,-	8575 387,-	8576 296,-	8742 500,-	8943 409,-	8591 597,-	8592 486,-
	300	8812 322,-	8813 256,-	8577 395,-	8578 303,-	8852 511,-	8853 424,-	8593 610,-	8594 499,-
	400	8822 375,-	8823 308,-	8579 455,-	8580 364,-	8862 616,-	8763 526,-	8595 731,-	8596 620,-
	500	8832 418,-	8833 347,-	8581 506,-	8582 414,-	8872 697,-	8873 607,-	8597 832,-	8598 722,-
750	250	8808 311,-	8809 244,-	8583 381,-	8584 289,-	8848 493,-	8849 404,-	8790 585,-	8791 475,-
	300	8818 317,-	8819 250,-	8585 387,-	8586 296,-	8858 503,-	8859 413,-	8792 599,-	8793 488,-
	400	8828 368,-	8829 296,-	8587 443,-	8588 352,-	8868 598,-	8869 507,-	8794 709,-	8795 599,-
	500	8838 410,-	8839 339,-	8589 496,-	8590 405,-	8778 683,-	8779 593,-	8796 816,-	8797 705,-

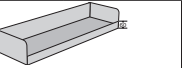
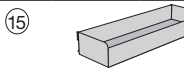
 <p>Shelf with lateral supports</p> <table border="1"> <thead> <tr> <th>Depth</th> <th>W 1000 mm</th> <th>W 750 mm</th> </tr> </thead> <tbody> <tr> <td>250</td> <td>8770 25,50</td> <td>8976 25,-</td> </tr> <tr> <td>300</td> <td>8771 27,30</td> <td>8977 26,70</td> </tr> <tr> <td>400</td> <td>8772 36,50</td> <td>8978 35,30</td> </tr> <tr> <td>500</td> <td>8773 46,80</td> <td>8979 45,90</td> </tr> </tbody> </table>	Depth	W 1000 mm	W 750 mm	250	8770 25,50	8976 25,-	300	8771 27,30	8977 26,70	400	8772 36,50	8978 35,30	500	8773 46,80	8979 45,90	 <p>Shelf with slot supports</p> <table border="1"> <thead> <tr> <th>Depth</th> <th>W 1000 mm</th> <th>W 750 mm</th> </tr> </thead> <tbody> <tr> <td>250</td> <td>8911 25,50</td> <td>8926 25,-</td> </tr> <tr> <td>300</td> <td>8912 27,30</td> <td>8927 26,70</td> </tr> <tr> <td>400</td> <td>8913 36,50</td> <td>8928 35,30</td> </tr> <tr> <td>500</td> <td>8914 46,80</td> <td>8929 45,90</td> </tr> </tbody> </table>	Depth	W 1000 mm	W 750 mm	250	8911 25,50	8926 25,-	300	8912 27,30	8927 26,70	400	8913 36,50	8928 35,30	500	8914 46,80	8929 45,90	 <p>Shelf with side supports</p> <table border="1"> <thead> <tr> <th>Depth</th> <th>W 1000 mm</th> <th>W 750 mm</th> </tr> </thead> <tbody> <tr> <td>350</td> <td>8635 40,30</td> <td>8636 39,10</td> </tr> <tr> <td>500</td> <td>8737 53,50</td> <td>8638 51,50</td> </tr> </tbody> </table>	Depth	W 1000 mm	W 750 mm	350	8635 40,30	8636 39,10	500	8737 53,50	8638 51,50	 <p>Bottom shelf with front edge</p> <table border="1"> <thead> <tr> <th>Depth</th> <th>W 1000 mm</th> <th>W 750 mm</th> </tr> </thead> <tbody> <tr> <td>350</td> <td>8646 40,30</td> <td>8647 39,10</td> </tr> <tr> <td>500</td> <td>8648 53,50</td> <td>8649 51,50</td> </tr> </tbody> </table>	Depth	W 1000 mm	W 750 mm	350	8646 40,30	8647 39,10	500	8648 53,50	8649 51,50	 <p>Sloped shelf 45° edge 60 mm high</p> <table border="1"> <thead> <tr> <th>Depth</th> <th>W 1000 mm</th> <th>W 750 mm</th> </tr> </thead> <tbody> <tr> <td>300</td> <td>8761 39,60</td> <td>8863 38,20</td> </tr> </tbody> </table>	Depth	W 1000 mm	W 750 mm	300	8761 39,60	8863 38,20
Depth	W 1000 mm	W 750 mm																																																								
250	8770 25,50	8976 25,-																																																								
300	8771 27,30	8977 26,70																																																								
400	8772 36,50	8978 35,30																																																								
500	8773 46,80	8979 45,90																																																								
Depth	W 1000 mm	W 750 mm																																																								
250	8911 25,50	8926 25,-																																																								
300	8912 27,30	8927 26,70																																																								
400	8913 36,50	8928 35,30																																																								
500	8914 46,80	8929 45,90																																																								
Depth	W 1000 mm	W 750 mm																																																								
350	8635 40,30	8636 39,10																																																								
500	8737 53,50	8638 51,50																																																								
Depth	W 1000 mm	W 750 mm																																																								
350	8646 40,30	8647 39,10																																																								
500	8648 53,50	8649 51,50																																																								
Depth	W 1000 mm	W 750 mm																																																								
300	8761 39,60	8863 38,20																																																								
 <p>Moveable divider</p> <table border="1"> <thead> <tr> <th>Depth</th> <th>W 1000 mm</th> </tr> </thead> <tbody> <tr> <td>250</td> <td>8658 6,80</td> </tr> <tr> <td>300</td> <td>8719 7,80</td> </tr> <tr> <td>400</td> <td>8446 8,50</td> </tr> <tr> <td>500</td> <td>8621 12,20</td> </tr> </tbody> </table>	Depth	W 1000 mm	250	8658 6,80	300	8719 7,80	400	8446 8,50	500	8621 12,20	 <p>Clip</p> <table border="1"> <thead> <tr> <th>Depth</th> <th>W 1000 mm</th> </tr> </thead> <tbody> <tr> <td>250</td> <td>5191 5,10</td> </tr> <tr> <td>300</td> <td>5192 5,30</td> </tr> </tbody> </table>	Depth	W 1000 mm	250	5191 5,10	300	5192 5,30	 <p>End support for wall protection</p> <table border="1"> <thead> <tr> <th>W 1000 mm</th> <th>W 750 mm</th> </tr> </thead> <tbody> <tr> <td>8765 8,50</td> <td>8766 8,20</td> </tr> </tbody> </table>	W 1000 mm	W 750 mm	8765 8,50	8766 8,20	 <p>center panel</p> <table border="1"> <thead> <tr> <th>W 1000 mm</th> <th>W 750 mm</th> </tr> </thead> <tbody> <tr> <td>8920 8,70</td> <td>8921 8,40</td> </tr> </tbody> </table>	W 1000 mm	W 750 mm	8920 8,70	8921 8,40	 <p>Case - with 60-mm high front</p> <table border="1"> <thead> <tr> <th>Depth</th> <th>W 1000 mm</th> </tr> </thead> <tbody> <tr> <td>300</td> <td>8708 55,80</td> </tr> </tbody> </table>	Depth	W 1000 mm	300	8708 55,80	 <p>Case - with 130-mm high front</p> <table border="1"> <thead> <tr> <th>Depth</th> <th>W 1000 mm</th> </tr> </thead> <tbody> <tr> <td>300</td> <td>8709 64,50</td> </tr> </tbody> </table>	Depth	W 1000 mm	300	8709 64,50																					
Depth	W 1000 mm																																																									
250	8658 6,80																																																									
300	8719 7,80																																																									
400	8446 8,50																																																									
500	8621 12,20																																																									
Depth	W 1000 mm																																																									
250	5191 5,10																																																									
300	5192 5,30																																																									
W 1000 mm	W 750 mm																																																									
8765 8,50	8766 8,20																																																									
W 1000 mm	W 750 mm																																																									
8920 8,70	8921 8,40																																																									
Depth	W 1000 mm																																																									
300	8708 55,80																																																									
Depth	W 1000 mm																																																									
300	8709 64,50																																																									

Total width of add-ons = Width quoted + 5 mm/shelf + 30 mm

Cantilever shelving *Univers*



Shelving support

Max. load per shelf: up to 300 mm deep **80 kg**
from 400mm deep **100 kg**

Max. load per unit
One-sided **400 kg**

double sided **800kg**

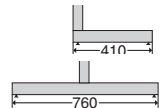

Combination table.		One-sided shelf support		Double-sided shelf racks					
Depth		Base support		Add-on		Base support		Add-on	
1000	H 2000 mm	8704	178,-	8705	108,-	8734	215,-	8735	126,-
	H 2250 mm	8706	214,-	8707	127,-	8736	257,-	8937	147,-
	H 2500 mm	8908	257,-	8909	157,-	8738	306,-	8739	180,-
750	H 2000 mm	8716	175,-	8917	104,-	8746	212,-	8747	122,-
	H 2250 mm	8918	210,-	8919	124,-	8948	254,-	8749	144,-
	H 2500 mm	8720	253,-	8721	152,-	8750	303,-	8751	175,-

Liftable panel
Melamine-covered desk top
W 500 x D 300 mm

8696 **89,-**

Max. load per shelf: 25kg
Total: 75kg

File trolley - 3 levels
with central divider,
rubber castors Ø 125 mm
W 900 x D 600 x H 1100 mm

8697 **549,-**

⑥ **Shelf with flaps**
Claps 230-mm wide with transparent plastic coverly

Depth W 1000 mm

300	8743	91,-
-----	------	------

⑦ **Hanging-file support**

Depth	W 1000 mm
300	8980 35,-

⑧ **Hanging-file device**
1 pce/rack due to stability

Depth	W 1000 mm
400	8676 138,-

⑨ **Telescopic shelf**
Shelf with lateral supports and telescopic shelf on rollers

Depth	W 1000 mm
300	8677 107,-

max. 150 mm

According to security directives shelves with more than 2 m in height have to be fixed together, to the wall or with the ceiling.

Wall connector	Ceiling connector
5087 2,-	8924 18,30

⑬ **Dividers for cases**

Guiders set (2 pcs)	8930	17,-
Divider 95 high	8938	5,30
Divider 130 high	8939	6,70

⑰ **Sliding-door cabinet**
With adjustable shelf is lockable

Depth	W 1000 mm
400	3189 279,-

⑱ **Top fascia - without illumination**

Depth	W 1000 mm	W 750 mm
500	8971 49,-	8972 47,-

With illumination incl. 15 W fluorescent lamp and electric series connection

500	8973 134,-	8974 127,-
-----	-------------------	-------------------

⑲ **Accessory**

Lateral clip	8934	4,10
Corridor sign right	8970	3,90
Corridor sign left	8989	3,90

max. 2500 mm

With rack-to-rack connector please quote the exact length



Rack-to-rack connector	
per metre	8688
Label	21,40
Transparent plastic, self-adhesive, with white cardboard	
per metre	5133
	4,80

Library shelving *Libra*

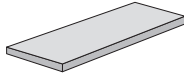
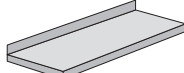

Libra

Library shelving in a modern design with numerous variation possibilities. A feature of the construction are the light but very stable 3 round steel tubular upright profiles, with diagonal welded metal stabilisers. All parts are powder coated in black RAL 9011, the frame has adjusting screws enabling a stable level assembly. The uprights have slots in them at 20 mm intervals for the fixture of the shelves. The individual shelves are available in E1 grade wood with melamine surfaces in beech, or steel shelves powder coated in light grey RAL 7035 colour. The shelves are available with a 90° edge which is 40 mm high.

	Steel Shelf in light grey without 90° edge	Depth 250
		Depth 300
	Steel Shelf in light grey with 90° edge	Depth 250
		Depth 300
	Wooden shelf Beech veneer with 90° edge	Depth 250
		Depth 300

Load capacity per shelf: 60 kg
Load capacity per unit: 400 kg
 Total width of shelf unit = width quoted + 15 mm/shelf + 40 mm

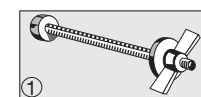

Unit securing kit
for securing together
two units back to back
(6 x pcs) 1185 1,10

Additional items

Steel shelves without edge	D 250
	D 300
Steel shelves with edge	D 250
	D 300
Wooden shelves with edge	D 250
	D 300

Library shelving *Libra*



Slot-in information fascia panel
100 mm high.



Normal shelves and angled shelves are
adjustable in height in 20 mm intervals.



External corner shelves for double sided units.
(at 90° to each other). The wooden shelves
have a rounded edge (see previous page) the
steel shelves have a straight edge.

Shelving in 2 width options, utilizing room space. Each width can be combined in intervals of 250 mm.

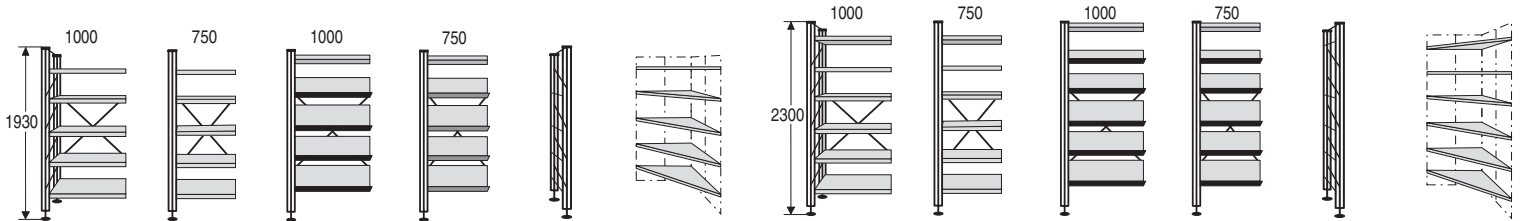
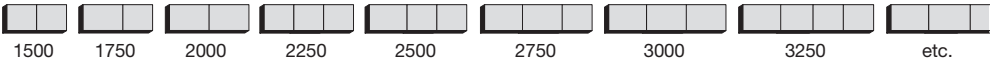

H 1930 mm, complete with shelves

1	2	3	4	5	6
Add-on W 1000 1 support 5 shelves	Add-on W 750 1 support 5 shelves	Add-on W 1000 1 support 1 shelf 4 sloped shelves	Add-on W 750 1 support 1 shelf 4 sloped shelves	Unit support for the end of the row	External corner unit for doublesided racks 2 x depth + 60 mm
1410 175,-	1411 169,-	-	-	1118 83,-	1119 233,-
1430 179,-	1431 175,-	1432 207,-	1433 197,-	1138 85,-	1139 244,-
1210 198,-	1211 191,-	-	-	1118 83,-	1119 233,-
1230 210,-	1231 201,-	1232 205,-	1233 195,-	1138 85,-	1139 244,-
1310 276,-	1311 268,-	-	-	1118 83,-	1319 275,-
1330 286,-	1331 278,-	1332 286,-	1333 276,-	1138 85,-	1339 289,-

H 2300 mm complete with shelves.

7	8	9	10	11	12
Add-on W 1000 1 support 6 shelves	Add-on W 750 1 support 6 shelves	Add-on W 1000 1 support 1 shelf 5 sloped shelves	Add-on W 750 1 support 1 shelf 5 sloped shelves	Unit support for the end of the row	External corner unit for doublesided racks 2 x depth + 60 mm
1420 207,-	1421 203,-	-	-	1128 95,-	1129 284,-
1440 214,-	1441 215,-	1442 242,-	1443 237,-	1148 99,-	1149 298,-
1220 237,-	1221 229,-	-	-	1128 95,-	1129 284,-
1240 240,-	1241 241,-	1242 248,-	1243 241,-	1148 99,-	1149 298,-
1320 322,-	1321 316,-	-	-	1128 95,-	1329 322,-
1340 334,-	1341 327,-	1342 339,-	1343 327,-	1148 99,-	1349 341,-

2	3	4	5	6	7	8	9
Additional shelf W 1000 mm	Additional shelf W 750 mm	Add. angled shelf W 1000 mm	Add. angled shelf W 750 mm	Additional lateral support	Movable divider Inscribable	Facia panel W 1000 mm	Facia panel W 750 mm
1197 1293 1290 1295 1390 1395	18,90 19,70 22,80 24,20 38,20 39,50	1198 1294 1291 1296 1391 1396	18,- 18,60 21,40 22,80 36,30 37,40	1297 1298	23,- 22,80	1182 1183 1182 1182 1183	2,50 2,60 2,50 2,60 2,50 2,60
1194 1199 1194 1199 1394 1399	8,50 9,40 8,50 9,40 9,60 10,30	1180 1181	25,90 24,-	1180 1181	25,90 24,-	1180 1181	25,90 24,-



Mmax.nl

T. 0031(0) 294285215

F. 0031(0) 294285204

E. info@Mmax.nl

W. www.Mmax.nl

W. www.Mmax.be

Shelving – June 2015

All prices are exclusive value-added tax.

All prices are ex-works, without VAT, exclusive packaging costs.
Payment within 10 days 2%, 30 days net.
Right of return within 10 days in its original packaging.

kerkmann

theo kerkmann · Büromöbelfabrik GmbH & Co. KG
Kerkmannstraße 1 · 33729 Bielefeld-Brake
Tel.: ++49 (0)521 7 70 05-0
Fax: ++49 (0)521 7 70 05-99
e-mail: info@kerkmann.de
internet: www.kerkmann.de